

**SA1**



**Rosyth School  
Mid-Year Examination 2021  
Mathematics  
Paper 1  
Primary 6**

Name: \_\_\_\_\_ Register No. \_\_\_\_\_

Class: Pr 6 - \_\_\_\_\_

Date: **10 May 2021** Parent's Signature: \_\_\_\_\_

Total Time for Booklets A and B : 1 hour

---

**Booklet A**

Instructions to Pupils:

1. Do not open this booklet until you are told to do so.
2. Follow all instructions carefully.
3. Shade your answers in the Optical Answer Sheet (OAS) provided.
4. You are not allowed to use a calculator.
5. Answer all questions.

Section	Maximum Mark	Marks Obtained
Paper 1 (Booklet A)	20	

\* This booklet consists of 9 pages (including this cover page). This paper is not to be reproduced in part or whole without the permission of the Principal.

Questions 1 to 10 carry 1 mark each. Questions 11 to 15 carry 2 marks each.  
For each question, four options are given. One of them is the correct answer.  
Make your choice (1, 2, 3 or 4). Shade the oval (1, 2, 3 or 4) on the Optical Answer Sheet.

*All diagrams in this paper are not drawn to scale unless stated otherwise.*

(20 marks)

- 
1. There are 17 985 people at a concert.  
Round this number to the nearest hundred.
- (1) 17 000
  - (2) 17 900
  - (3) 17 990
  - (4) 18 000
2. Mdm Ling bought 2 litres of orange juice. She poured all the juice into smaller bottles of  $\frac{1}{4}$  l each. How many of such bottles will there be in the end?
- (1) 6
  - (2) 2
  - (3) 8
  - (4) 4

3. In the figure, ABCD and ADEF are parallelograms. Which of the following pairs of lines are parallel?

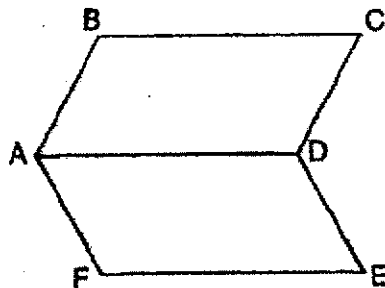

- (1) BC and DE  
(2) BC and FE  
(3) AB and AD  
(4) AB and AF
4. Express  $\frac{7}{9}$  as a decimal. Round your answer to 2 decimal places.
- (1) 0.77  
(2) 0.78  
(3) 1.28  
(4) 1.29

5. The table below shows the number of library books borrowed by some pupils on a particular day.

Number of books borrowed	0	1	2	3	4
Number of pupils	6	8	10	12	4

How many pupils borrowed at least 2 library books?

- (1) 10  
(2) 16  
(3) 22  
(4) 26
6. Simplify the algebraic equation  $5w + 6 - 2w + 11 - 9 - w$ .
- (1)  $2w + 8$   
(2)  $3w + 2$   
(3)  $7w + 8$   
(4)  $8w + 26$
7. There are 28 blue marbles and 52 red marbles in a box. What is the ratio of the number of blue to red marbles in the box?
- (1) 2 : 3  
(2) 4 : 13  
(3) 7 : 26  
(4) 7 : 13

8. In the figure below,  $PRS$  is an isosceles triangle and  $PR = PS$ .  $\angle PSR = 40^\circ$  and  $\angle PRA = 70^\circ$ . Find  $\angle y$ .

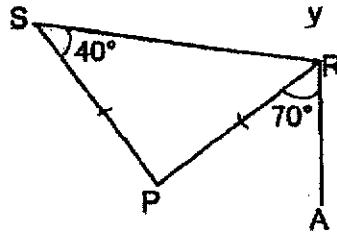

- (1)  $150^\circ$   
 (2)  $260^\circ$   
 (3)  $290^\circ$   
 (4)  $320^\circ$
9. Four containers with some water are shown below. Which container has the least amount of water?

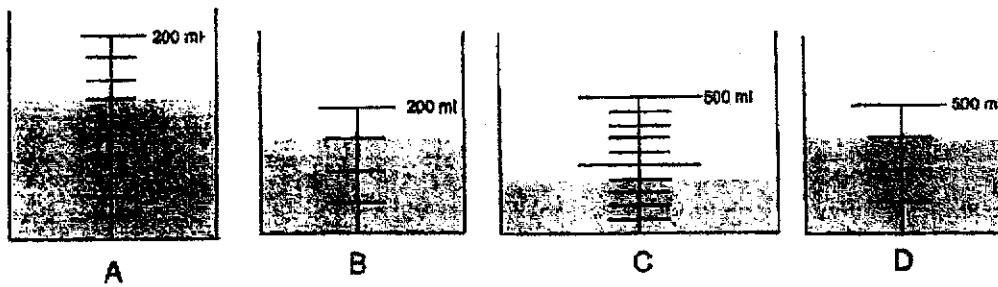

- (1) A  
 (2) B  
 (3) C  
 (4) D

10. Arrange the following fractions from the largest to the smallest.

$$\frac{2}{11}, \frac{1}{5}, \frac{2}{9}$$

(1)  $\frac{1}{5}, \frac{2}{9}, \frac{2}{11}$

(2)  $\frac{2}{9}, \frac{1}{5}, \frac{2}{11}$

(3)  $\frac{2}{11}, \frac{1}{5}, \frac{2}{9}$

(4)  $\frac{2}{11}, \frac{2}{9}, \frac{1}{5}$

11. The figure below is made up of a parallelogram EFGH and a right-angled triangle AGH. Find  $\angle GAH$ .

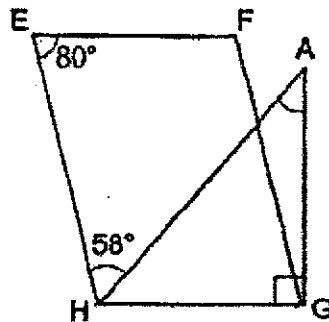

- (1)  $42^\circ$   
(2)  $48^\circ$   
(3)  $58^\circ$   
(4)  $80^\circ$

12. At a post office, the overseas postage rates for bulk parcels are shown in the table below. Mr Tan posted a parcel which weighs 5.8 kg to Malaysia and another parcel which weighs 7.2 kg to Hong Kong. How much did he pay for sending both parcels?

Destinations (Zone)	Postal Rate	
	First 5 kg	Additional kg or part thereof
Zone A: Malaysia	\$16	\$3
Zone B: Brunei, Hong Kong, Indonesia, Philippines, Taiwan and Thailand	\$30	\$5

- (1) \$46
- (2) \$54
- (3) \$59
- (4) \$64

13. The figure is made up of a square and 2 identical rectangles placed overlapping the square. The length  $AB$  is equal to the length  $BC$ . The area of the shaded parts is  $64 \text{ cm}^2$ . What is the area of the unshaded parts?

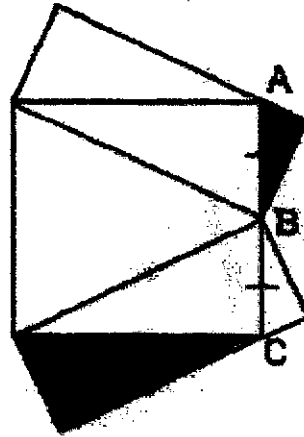

- (1)  $128 \text{ cm}^2$
- (2)  $256 \text{ cm}^2$
- (3)  $320 \text{ cm}^2$
- (4)  $384 \text{ cm}^2$



14. An open rectangular box contains some 1-cm cubes as shown below. How many more 1-cm cubes are needed to fill the box completely?

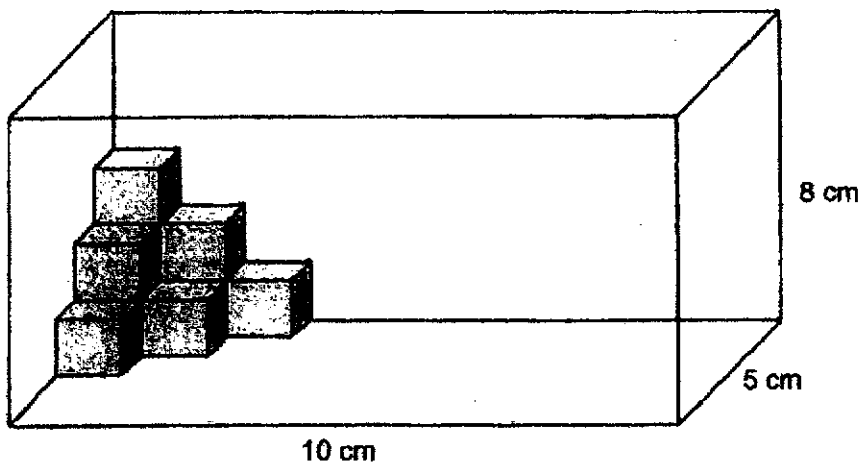

- (1) 390  
(2) 391  
(3) 394  
(4) 400
15. Liling made some puffs.  $\frac{2}{3}$  of them were sardine puffs and the rest were curry puffs. After giving away 35 sardine puffs and  $\frac{1}{2}$  of the curry puffs, she had  $\frac{1}{4}$  of the puffs left. How many puffs had Liling left?
- (1) 5  
(2) 15  
(3) 45  
(4) 60



**Rosyth School  
Mid-Year Examination 2021  
Mathematics  
Primary 6**

Name: \_\_\_\_\_

Register No. \_\_\_\_\_

Class: Pr 6 - \_\_\_\_\_ Group: \_\_\_\_\_

Date: **10 May 2021**

Parent's Signature: \_\_\_\_\_

Total Time for Booklets A and B : 1 hour

---

**PAPER 1  
(BOOKLET B)**

Instructions to Pupils:

1. Do not open this booklet until you are told to do so.
2. Follow all instructions carefully.
3. You are not allowed to use a calculator.
4. Write your answers in the booklet.
5. Answer all questions.

Section	Maximum Mark	Marks Obtained
<b>Paper 1 (Booklet B)</b>	<b>25</b>	

\* This booklet consists of 9 pages (including this cover page)

This paper is not to be reproduced in part or whole without the permission of the Principal.

Questions 16 to 20 carry 1 mark each. Write your answers in the spaces provided. For questions which require units, give your answers in the units stated.

Do not write in this space

**All diagrams in this paper are not drawn to scale unless stated otherwise.** (5 marks)

16. Mrs Ramesh bought a packet of sweets for \$2.95. How much did she pay for 40 packets?

Ans: \$ \_\_\_\_\_

17. Study the diagram below carefully.

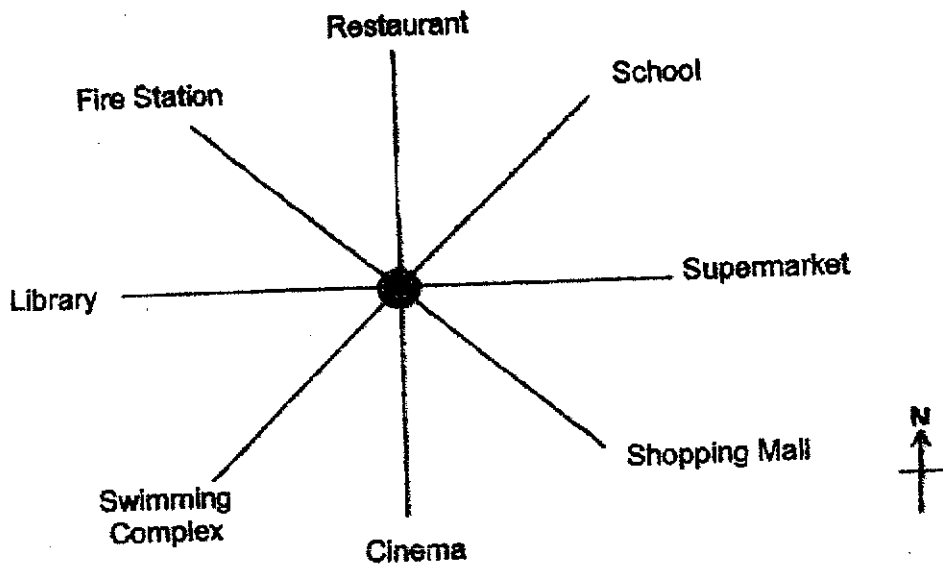

Dorothy is facing the fire station. Which building will she face when she turns  $135^\circ$  in the clockwise direction?

Ans: \_\_\_\_\_

18. Find the value of  $2\frac{3}{4} - 1\frac{2}{5}$ . Give your answer as a mixed number in the simplest form.

Do not write  
in this space

Ans: \_\_\_\_\_

19. There were 160 pupils in a drama club last year. This year, there are 120 pupils in the same club. What is the percentage decrease in the number of pupils who join the drama club this year?

Ans: \_\_\_\_\_ %

20. When Sunny reached a cinema at 6.50 p.m., he was already 10 minutes late for the movie. The movie ended at 9.00 p.m. . How long was the duration of the movie?

Ans: \_\_\_\_\_ h

Questions 21 to 30 carry 2 marks each. Show your workings clearly in the space provided for each question and write your answers in the spaces provided. For questions which require units, give your answers in the units stated.

Do not write  
in this space

**All diagrams in this paper are not drawn to scale unless stated otherwise.**  
(20 marks)

21. The solid below is made up of 14 cubes.  
In the grid below, draw the side view of the solid.

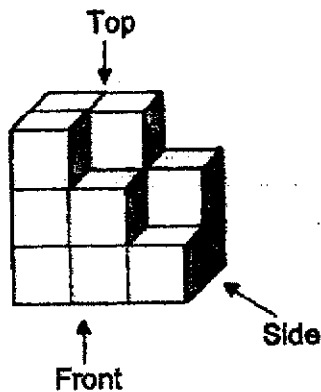

Side View

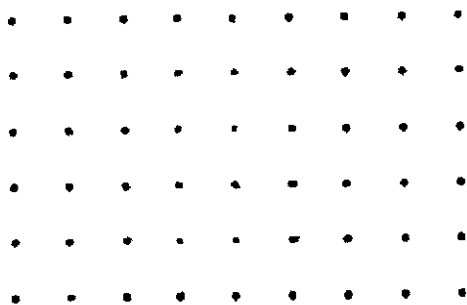

22. The graph below shows the number of burgers sold from Monday to Thursday. The number of burgers sold on Friday is equal to the average number of burgers sold from Monday to Thursday. What is the number of burgers sold on Friday?

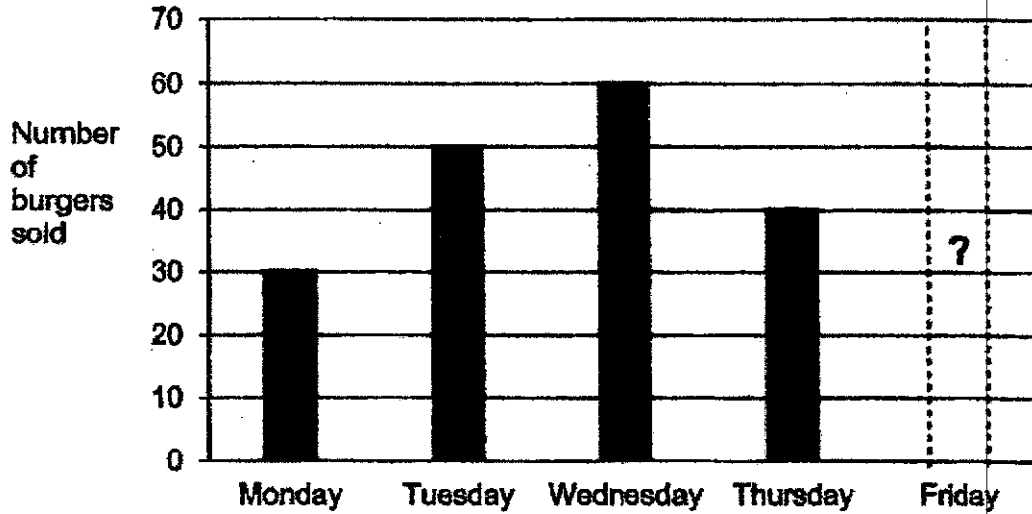

Do not write  
in this space

Ans: \_\_\_\_\_

23. Kelly bought a dress for \$50 and 3 blouses at \$ $w$  each. If the total cost of the dress and 3 blouses was \$110, find the value of  $w$ .

Ans: \_\_\_\_\_

24. In the diagram below,  $STW$  is a trapezium and  $SU$  is parallel to  $WV$ .  
 $TU = UV$ . Find  $\angle TUV$ .

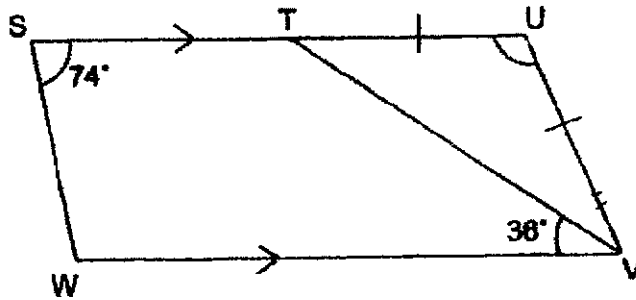

Do not write  
 in this space

Ans: \_\_\_\_\_

25. Mrs Koh bought 90 tarts and repacked them into boxes of 8. How many more tarts would she need to buy to fill up the last box of 8 tarts?

Ans: \_\_\_\_\_

26. Jack poured out two bottles filled with 16 litres of water each into an empty tank as shown below. What was the height of the water level in the tank after he had poured out all the water from the bottles?

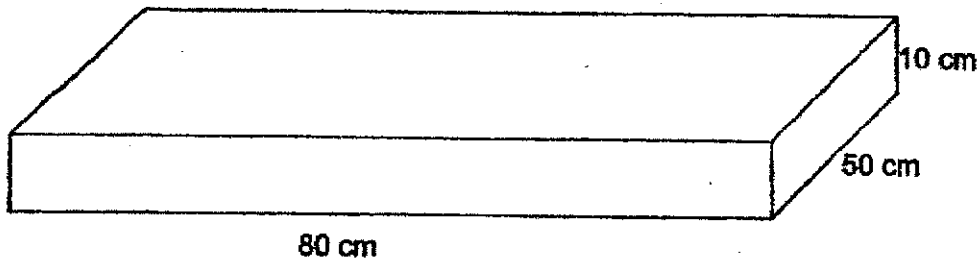

Do not write  
in this space

Ans: \_\_\_\_\_ cm

27. The ratio of the number of stickers Carol had to the number of stickers Siti had was 3 : 4. After Carol's brother had given her 20 more stickers, Carol had 62 stickers. How many stickers did Siti have?

Ans: \_\_\_\_\_





28. Starting on a Monday, Ken saved some money every day. He increased his savings by 20 cents each day until Thursday. He saved a total of \$6 by the end of the four days. How much did he save on Monday?

Do not write  
in this space

Ans: \$ \_\_\_\_\_

29. There were 5 bowls containing the same number of grapes each at first. Then, 4 grapes were eaten from each bowl. In the end, the total number of grapes left in the 5 bowls was the same as the total number of grapes in the 3 bowls at first. What was the number of grapes in each bowl at first?

Ans: \_\_\_\_\_

30. In the square grid below, AB and BC are straight lines.

(a) Measure and write down the size  $\angle ABC$ .

(b) AB and BC form two sides of a trapezium ABCD. AD is parallel to BC and is twice the length of BC. Complete the drawing of trapezium ABCD. [1]

Do not write  
in this space

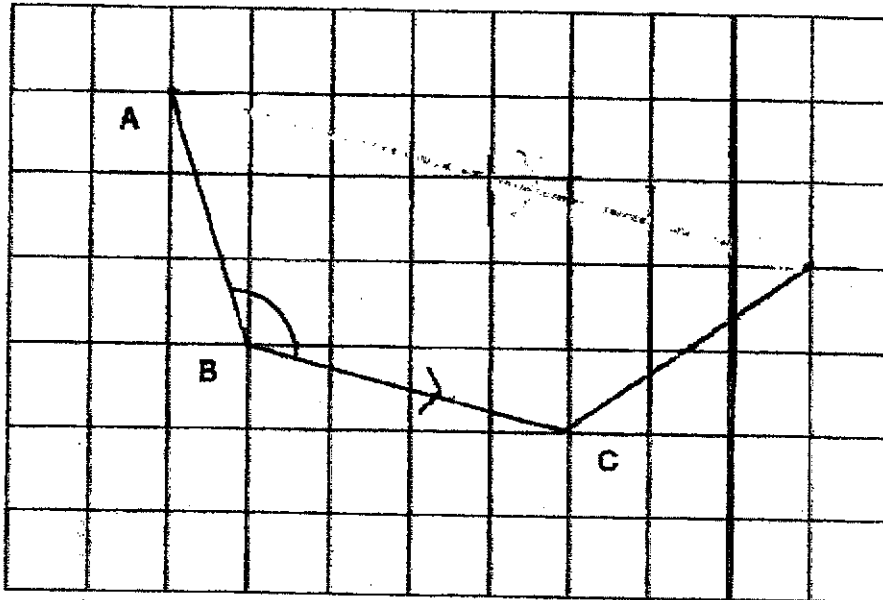

Ans: (a) \_\_\_\_\_ ° [1]

End of Paper



**Rosyth School  
Mid-Year Examination 2021  
Mathematics  
Primary 6**

Name: \_\_\_\_\_

Register No. \_\_\_\_\_

Class: Pr 6 - \_\_\_\_\_ Group: \_\_\_\_\_

Date: 10 May 2021

Parent's Signature: \_\_\_\_\_

Time: 1 h 30 min

---

**PAPER 2**

**Instructions to Pupils:**

1. Do not open this booklet until you are told to do so.
2. Follow all instructions carefully.
3. **Show your workings clearly** as marks are awarded for correct working.
4. Write your answers in this booklet.
5. You are allowed to use a calculator.
6. Answer all questions.

Questions	Maximum Mark	Marks Obtained
Q 1 to 5	10	
Q 6 to 17	45	

Section	Maximum Mark	Marks Obtained
Paper 1	45	
Paper 2	55	
<b>Total</b>	<b>100</b>	

\* This booklet consists of **18** pages (including this cover page)

This paper is not to be reproduced in part or whole without the permission of the Principal.

Questions 1 to 5 carry 2 marks each. Show your working clearly in the space provided for each question and write your answers in the spaces provided. For questions which require units, give your answers in the units stated.

Do not write in this space

**All diagrams in this paper are not drawn to scale unless stated otherwise.**  
(10 marks)

1. John bought 15 identical plates. Siti bought 11 such plates. She also bought 5 cups for \$40. Both John and Siti spent the same amount of money. What was the cost of 1 plate?

Ans: \$ \_\_\_\_\_

2. Study the diagram below.

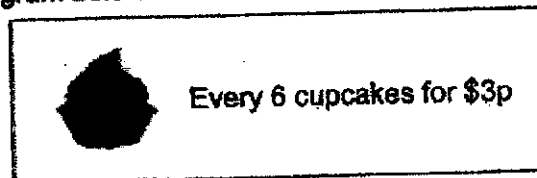

Mrs Devi bought 24 cupcakes. She gave the cashier \$50. How much change would she receive? Give your answer in terms of p.

Ans: \$ \_\_\_\_\_

3. In the figure below, the rectangle ABCD is made up of two parts Y and W. The length of AB is twice of the length of BC. Part Y is formed by a semicircle and the line AD. The perimeter of Y is 90 cm. The perimeter of the shaded part, W, is 230 cm. Find the perimeter of the rectangle ABCD.



Ans: \_\_\_\_\_ cm

Do not  
write in  
this space

4. Mark and Ali collected some newspapers for recycling. The ratio of the mass of the newspapers Mark collected to the mass of the newspapers Ali collected was 1 : 3. After their neighbours gave them 42 kg of newspapers each, their ratio became 2 : 3. How many kilograms of newspapers did both of them collect altogether in the end?

Ans: \_\_\_\_\_ kg

5. Ken can paint a room in 8 hours. Raja can paint the same room in 10 hours.

Do not  
write in  
this space

Each of the statements is either true, false or not possible to tell from the information given. For each statement, put a tick (✓) to indicate your answer.

Statement	True	False	Not Possible To Tell
Both of them will take less than 4 hours to finish painting the room together.			
With a third person to paint the same room together, the 3 of them could finish painting the room in less than 4 hours.			

For Questions 6 to 17, show your working clearly in the space provided for each question and write your answers in the spaces provided. The number of marks available is shown in brackets [ ] at the end of each question or part-question. For questions which require units, give your answers in the units stated.

Do not write in this space

**All diagrams in this paper are not drawn to scale unless stated otherwise.**

**(45 marks)**

6. The figure below is not drawn to scale. ABCD is a parallelogram. HMJ is a triangle.  $\angle ADJ = 65^\circ$ ,  $\angle MHJ = 93^\circ$  and  $\angle BMJ = 140^\circ$ .

(a) Find  $\angle BCD$ .

(b) Find  $\angle HJM$ .

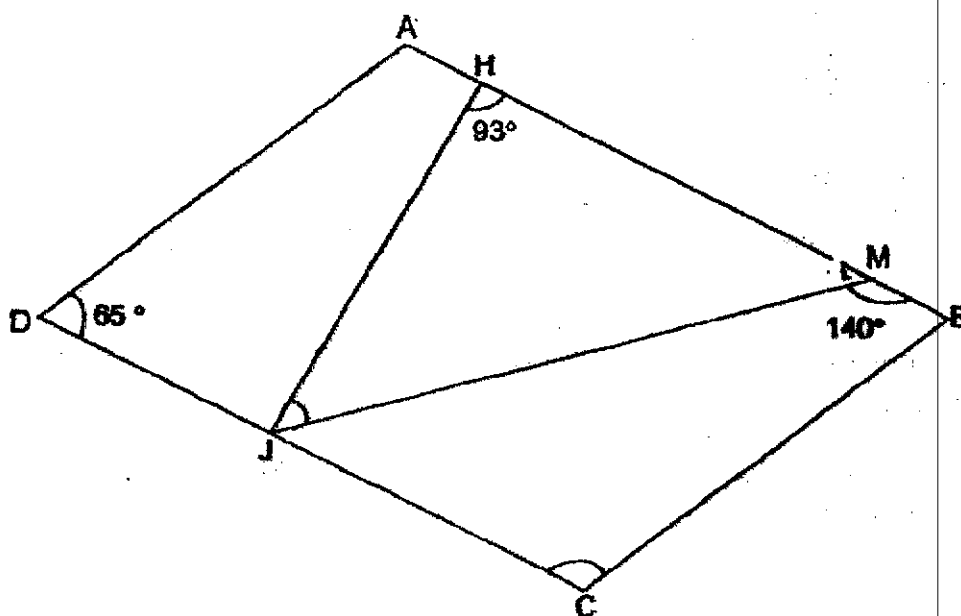

Ans: (a) \_\_\_\_\_ [1]

(b) \_\_\_\_\_ [2]



7. The graph below shows the number of cups of bubble tea sold in a shop from Monday to Friday.

Do not write in this space

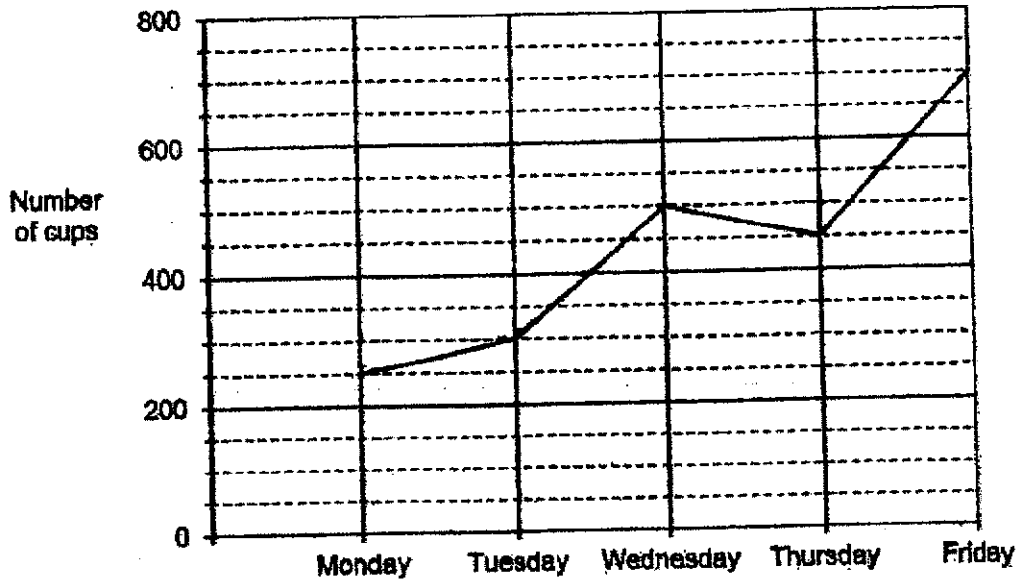

- (a) How many more cups of bubble tea were sold on Wednesday than on Tuesday?
- (b) What is the percentage increase in the number of cups of bubble tea sold on Friday compared to Monday?

Ans: (a) \_\_\_\_\_ [1]

(b) \_\_\_\_\_ [2]



8. The table below shows the cost of each can of paint.

Paint	Red	Blue	Yellow
Cost	\$9	\$35	\$32

Mr Tan bought some cans of red, blue and yellow paint. The ratio of the number of cans of red paint to the number of cans of blue paint to the number of cans of yellow paint was 7 : 5 : 6. He paid \$2580 for all the cans of paint. How many cans of red paint did he buy?

Do not  
write in  
this space

Ans: \_\_\_\_\_ [3]

9. Minah had a collection of toys.  $\frac{3}{5}$  of them were marbles and the rest were dolls and car models. The number of dolls was  $\frac{1}{4}$  of the number of car models. There were 156 more marbles than the dolls. How many toys did she have in her collection?

Do not  
write in  
this space

Ans: \_\_\_\_\_ [3]

10. The figure shows a cuboid made up of some identical unit cubes. 2 shaded cubes are removed and the remaining solid is painted red. What is the total number of painted faces?

Do not write in this space

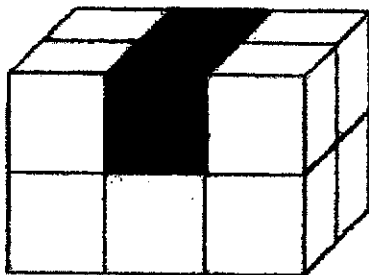

Ans: \_\_\_\_\_ [3]



11. Malar had a rectangular piece of paper. She folded it along the dotted line as shown in Figure 1. Then, she folded the paper again along the dotted line as shown in Figure 2. Finally, the folded paper is as shown in Figure 3. Given that  $\angle EFG = 72^\circ$  and  $\angle JEH = 43^\circ$ , find

- (a)  $\angle FEH$   
 (b)  $\angle EJH$

Do not write in this space

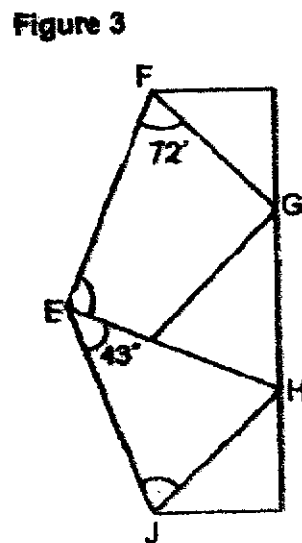
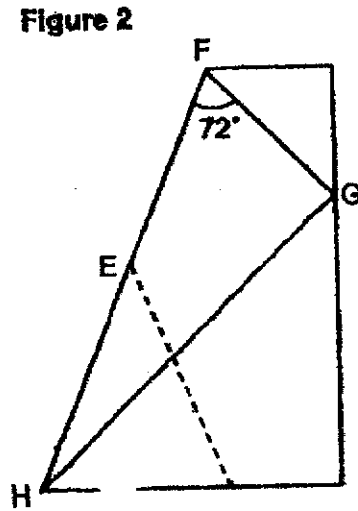
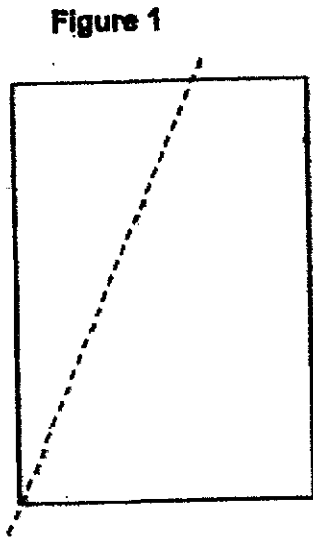

11. (to be continued here)

Do not  
write in  
this space

Ans: (a) \_\_\_\_\_ [2]

(b) \_\_\_\_\_ [2]

12. At first, Mr Menon had 380 more books than magazines in his bookshop. He then sold  $\frac{1}{4}$  of the books and  $\frac{3}{5}$  of the magazines. The number of books left was 600 more than the number of magazines left. What was the total number of books and magazines Mr Menon had at first?

Do not  
write in  
this space

Ans: \_\_\_\_\_ [4]

13. Tank X was  $\frac{4}{5}$  filled with water. Tank Y was empty. All the water from Tank X was poured into Tank Y. After that, Tank Y needed another  $1944 \text{ cm}^3$  of water to fill to its brim.

- (a) What was the volume of water in Tank X at first?  
(b) What was the height of Tank Y?

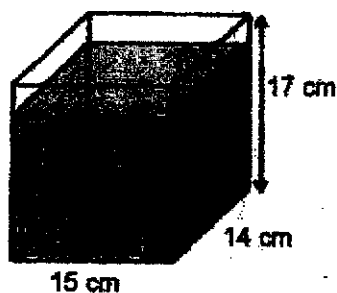

Tank X

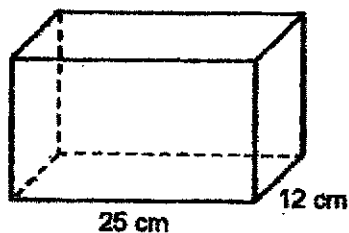

Tank Y

Do not  
write in  
this space

Ans: (a) \_\_\_\_\_ [2]

(b) \_\_\_\_\_ [2]



14. In the figure, ABCD is a parallelogram. AD = AE. BD and EAC are straight lines.  $\angle DFC = 100^\circ$ ,  $\angle EAB = 155^\circ$  and  $\angle AED = 35^\circ$ .

Do not write in this space

- (a) Find  $\angle ADC$   
 (b) Find  $\angle CBF$

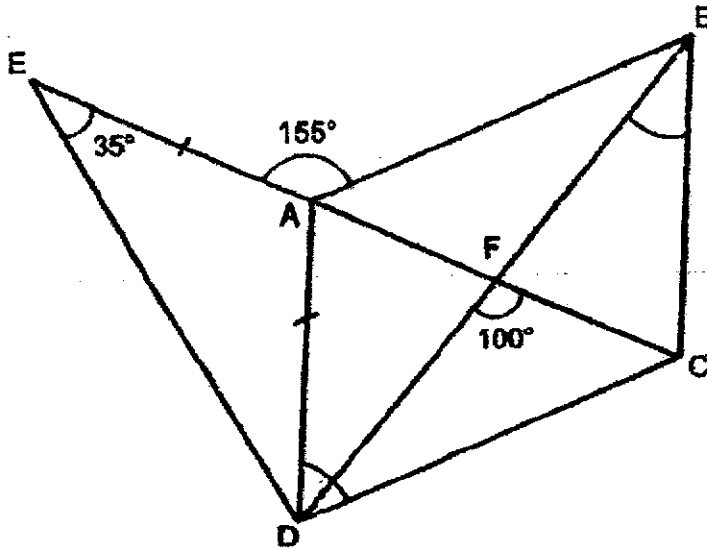

Ans: (a) \_\_\_\_\_ [2]

(b) \_\_\_\_\_ [2]





15. In the figure, QM is the arc of a quarter circle. MNP is a triangle and MN is perpendicular to SN. SN = 7 cm and MN = 19 cm.

- (a) Find the total area of the shaded parts.
- (b) The perimeter of the unshaded triangle is 43.5 cm. Find the perimeter of the shaded parts.

(Take  $\pi = \frac{22}{7}$ )

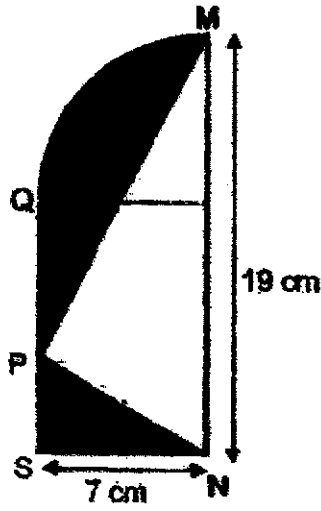

Do not  
write in  
this space





Ans: (a) \_\_\_\_\_ [3]

(b) \_\_\_\_\_ [2]



16. A test pattern for TV screens made up of black and white dots is shown below. The dots will appear at intervals of 1 second.

Do not write in this space

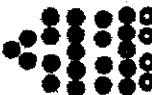
Time	Dots on TV screen	Number of black dots	Number of white dots	Total number of dots
1st sec		3	0	3
2nd sec		3	4	7
3rd sec		7	5	12
4th sec		12	4	16
5th sec		16	5	21
6th sec		21	4	25

- (a) How many black dots are there at the 8th second mark?
- (b) What is the total number of black and white dots at the 30th second mark?
- (c) At which second mark will the total number of the black and white dots be 188?  
*difference between*

16. (to be continued here)

Do not  
write in  
this space

Ans: (a) \_\_\_\_\_ [1]

(b) \_\_\_\_\_ [2]

(c) \_\_\_\_\_ [2]



17. Mrs Park had 420 more pens than notebooks at her shop. After selling 75% of the pens and some notebooks, she had 20% of the total number of pens and notebooks left. There were 21 notebooks left. What was the total number of pens and notebooks she had at first?

Do not  
write in  
this space

Ans: \_\_\_\_\_ [4]

---

**End of paper**  
**Have you checked your work?**

## ANSWER KEY

**YEAR : 2021**  
**LEVEL : PRIMARY 6**  
**SCHOOL : ROSYTH**  
**SUBJECT : MATHEMATICS**  
**TERM : MID-YEAR EXAM**

### BOOKLET A (PAPER 1)

Q1	4	Q2	3	Q3	2	Q4	2	Q5	4
Q6	1	Q7	4	Q8	2	Q9	1	Q10	2
Q11	2	Q12	4	Q13	3	Q14	1	Q15	2

### BOOKLET B (PAPER 1)

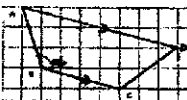
Q16	$40 \times \$2.95 = 4 \times 10 \times \$2.95$ $= \$11.80 \times 10 = \$118$	Q17	Supermarket
Q18	$2\frac{3}{4} - 1\frac{2}{5} = 2\frac{15}{20} - 1\frac{8}{20} = 1\frac{7}{20}$	Q19	$\% \downarrow \rightarrow \frac{160-120}{100} \times 100\% = 25\%$
Q20	$2\text{h}10\text{min} + 10\text{min} = 2\text{h}20\text{min}$ $= 2\frac{1}{3}\text{h}$	Q21	
Q22	Average $\rightarrow \frac{30+50+60+40}{4} = 45$	Q23	Total cost $\rightarrow \$(50+3w) = \$110$ $3w \rightarrow 110 - 50 = 60$ $W \rightarrow 60 \div 3 = 20$
Q24	$\angle TUV \rightarrow 180^\circ - 36^\circ - 36^\circ = 108^\circ$	Q25	Extra $\rightarrow 96 - 90 = 6$
Q26	Poured out $\rightarrow 16\text{L} \times 2 = 32\text{L}$ $= 32000\text{cm}^3$ Height $\rightarrow 32000 \div 80 \div 50 = 8\text{cm}$	Q27	Carol (at first) $\rightarrow 62 - 20 = 42$ $3u \rightarrow 42$ $4u \rightarrow 42 \div 3 \times 4 = 56$
Q28	$4u \rightarrow \$6 - \$0.20 \times 6 = \$4.80$ $1u \rightarrow \$4.80 \div 4 = \$1.20$	Q29	2 bowls $\rightarrow 4 \times 5 = 20$ 1 bowl $\rightarrow 20 \div 2 = 10$
Q30	a) $122^\circ$ b) 		

### BOOKLET B (PAPER 2)

Q1	15plates = 11 plates + 5cups 4plates = 5cups	Q2	6cupcakes $\rightarrow \$(3p)$ 24 cupcakes $\rightarrow \$(12p)$
----	---	----	---

	4plates → \$40 1plates → \$10		Change → \$(50 - 12p)
Q3	Perimeter → 70 + 70 + 70 = 210cm	Q4	Total → 4u + 6u = 10u 10u → $\frac{10}{3} \times 42 = 140\text{kg}$
Q5	False Not Possible To Tell	Q6	a) $\angle BCD \rightarrow 180^\circ - 65^\circ = 115^\circ$ b) $\angle MJC \rightarrow 180^\circ - 93^\circ - 40^\circ = 47^\circ$
Q7	a) Wed - Tuesday → 500 - 300 = 200 b) Diff → 700 - 250 = 450 % ↑ → $\frac{450}{250} \times 100\% = 180\%$	Q8	Total cost of 1 set → \$63 + \$175 + \$192 = \$430 No of set C → $\$2580 \div \$430 = 6$ sets Red paint → 6 x 7 = 42
Q9	$\frac{\text{dolls}}{\text{total}} \rightarrow \frac{2}{5} \times \frac{1}{5} = \frac{2}{25}$ $\frac{\text{marble-dolls}}{\text{total}} \rightarrow \frac{3}{5} - \frac{2}{25} = \frac{15}{25}$ $\frac{13}{25} \rightarrow 156$ $\frac{156}{25} \rightarrow \frac{156}{13} \times 25 = 300$	Q10	Total no of faces → 6 x 4 + 4 x 2 = 32 Painted → 32 - 4 + 6 = 34
Q11	a) $\angle FEH \rightarrow 180^\circ - 43^\circ - 43^\circ = 94^\circ$ b) $\angle EAG \rightarrow 180^\circ - 90^\circ - 72^\circ = 18^\circ$ $\angle AAJ \rightarrow 90^\circ - 18^\circ - 18^\circ = 54^\circ$ $\angle ABJ \rightarrow 18^\circ + 43^\circ = 61^\circ$ $\angle EIH \rightarrow 180^\circ - 54^\circ - 61^\circ = 65^\circ$	Q12	15u + 285 - 8u = 600 7u = 600 - 285 = 315 1u = 315 ÷ 7 = 45 40u + 380 = 40 x 45 + 380 = 2180
Q13	a) Tank X → 15 x 14 x 17 x $\frac{4}{5}$ = 2856cm <sup>3</sup> b) Tank Y (capacity) → 4800 ÷ 25 ÷ 12 = 16cm	Q14	a) $\angle ADC \rightarrow 30^\circ + 55^\circ = 85^\circ$ b) $\angle DBC \rightarrow 30^\circ$
Q15	a) $(\frac{1}{4} \times \frac{22}{7} \times 7 \times 7 + 84) - 66.5 = 56\text{cm}^2$ b) $\frac{1}{4} \times \frac{22}{7} \times \frac{14}{1} = 11$ 24.5 + 11 + 12 + 7 = 54.5cm	Q16	a) 8 <sup>th</sup> sec(B) → 21 + 4 + 5 = 30 b) 30 - 6 = 24 24 ÷ 2 = 12 12 x 9 = 108 25 108 = 133 c) 22 <sup>nd</sup> even no → 22 x 2 = 44
Q17	X → 1u + 189 3u → 21 + 189 = 210 At First → 8u + 420 = $(210 \times \frac{8}{3}) + 420 = 980$		

2  
END